

**OSSTEM<sup>®</sup>**  
IMPLANT

Surgery System

# SM3

## OPERATION MANUAL

Please read this Operation Manual carefully before use, and file for future reference.



OM-EZ746E

MADE IN JAPAN

CE 0197

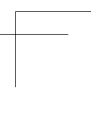
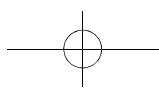
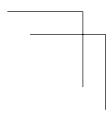
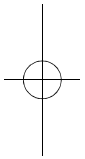
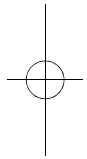
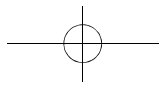
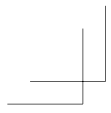

# SM3

Thank you for purchasing the OSSTEM SM3 series surgical unit.

We recommend that prior to use, you carefully read this document regarding instructions for use, handling method, or maintenance check so that you can carry on using the unit in the future. In addition, keep this operation manual in a place where a user can refer to it at any given time.



## ◆ Intended to Use

SM3 series is intended for use in dental oral surgery by qualified personnel.

## Contents



|   |    |
|---|----|
| 1. Safety precautions prior to use          | 2  |
| 2. Package Contents                         | 4  |
| 3. Control Unit and Foot Control            | 5  |
| 4. Installation                             | 7  |
| 5. Setting                                  | 11 |
| 6. Operation                                | 12 |
| 7. Protection Circuit                       | 15 |
| 8. Error Code & Troubleshooting             | 15 |
| 9. Fuse Replacement                         | 17 |
| 10. Maintenance                             | 17 |
| 11. Sterilization                           | 18 |
| 12. Contra Angle Handpieces and Accessories | 19 |
| 13. Specification                           | 19 |
| 14. Disposing Product                       | 19 |
| 15. Symbols                                 | 20 |
| 16. EMC Information                         | 20 |

## ◆ Classification of equipment

- Type of protection against electric shock :
  - Class I equipment
- Degree of protection against electric shock :
  - Type BF applied part 
- Method of sterilization or disinfection recommended by the manufacture :
  - See 11. Sterilization
- Degree of protection against ingress of water as detailed in the current edition of IEC 60529 :
  - Foot Control: IPX8 (Protected against the effects of continuous immersion in water)
- Degree of safety of application in the presence of a flammable anesthetic mixture with air or with oxygen or nitrous oxide :
  - Foot Control: Category AP Equipment 
- Mode of operation :
  - Intermittent operation

## Cautions for handling and operation

- Read these safety cautions thoroughly before use and operate the product properly.
- These indicators are to allow you to use the product safely, prevent danger and harm to you and others. These are classified by degree of danger, damage and seriousness. All indicators concern safety, be sure to follow them.

| Classification   | Degree of Danger or Damage and Seriousness   |
|--|--|
|  <b>WARNING</b> | Explains an instruction where personal injury or physical damage may occur.        |
|  <b>CAUTION</b> | Explains an instruction where minor to medium injury or physical damage may occur. |
|  <b>NOTICE</b>  | Explains an instruction that should be observed for safety reasons.                |

## 1. Safety precautions prior to use

Read Handpiece's Operation manual carefully before use.

### **WARNING**

- TO PREVENT ELECTRIC SHOCK Do not unplug the AC Power cord with wet hands.
- TO PREVENT ELECTRIC SHOCK Be sure to prevent water on the Control Unit.
- TO PREVENT ELECTRIC SHOCK Use an electrical outlet that is grounded.
- The system may present a possibility of malfunction when used in the presence of an electromagnetic interference wave. Do not install the system in the vicinity of the device which emits magnetic waves. Turn off the Main Power Switch of the Control Unit of this system when an ultrasonic oscillation device or an electrode knife is located in the vicinity is used.

### **CAUTION**

- The accuracy of the Torque Monitor depends on the high precision performance of the handpiece attached to the micromotor. Real torque value may not otherwise be correctly displayed. To guarantee handpiece torque accuracy, that matches the monitor display system, USE ONLY the OSSTEM contra angle handpieces listed on "12. Contra Angle Handpieces and Accessories". When other handpiece had connected, it may not output accurate torque which indicated on handpiece.
- SM3 series needs special precautions regarding EMC and needs to be installed and put into service according to the EMC information. (Refer to 16. EMC Information)
- Portable and mobile RF (Radio Frequency) communications equipment can affect SM3 series. Do not use RF equipment outskirts for the product.
- The use of accessories, Motors and cables other than those specified, with the exception of Motors and cables sold by the manufacturer of SM3 series as replacement parts for internal components, may result in increased EMISSIONS or decreased IMMUNITY of the Control Unit.
- SM3 series should not be used adjacent to or stacked with other equipment and that if adjacent or stacked use is necessary, the Control Unit should be observed to verify normal operation in the configuration in which it will be used.
- When operating this system always consider the safety of the patient.
- Do not attempt to disassemble the Control Unit /Foot Control / Micromotor nor temper with the mechanism.
- Check for vibration, noise and overheating before use and if any abnormalities are found in use, stop using immediately and contact dealer.
- Use an electrical outlet that is grounded.
- Do not drop, hit, or subject to excessive shock.
- Do not bend the Irrigation Tube while the irrigation pump is operating. It could cause tube breakage.
- Do not use bent, damaged or sub-standard burs or drill. The Shank could bend or brake.
- Do not exceed the recommended speed and torque.

- After each Operation, be sure to lubricate and sterilize the handpiece as soon as it's cleaned. Blood coagulation can cause corrosion and rusting. However, do not lubricate the Micromotor. Oil could generate excessive heat and cause damage.
- The Control Unit can be cleaned with a moist cloth. Disconnect the power supply before cleaning. The Control Unit and the Foot Control cannot be sterilized by any method.
- When the system is very frequently used, consider the maintenance of a small stock of replaceable parts.
- Do not disconnect the Motor Cord from the motor.
- Do not wipe with or, clean or immerse in, high acid water or sterilizing solutions.
- Follow the table below for the motion time of motor and handpiece. Continuous use over a long time with high torque may cause the overheating of the handpiece, which in turn may result in an accident.
- Applied parts for patient and/or operator is Handpiece.
- Do not fixate the eyes of LED light.
- If any abnormalities (dark, do not light on or flashing) are found for LED, stop using the it immediately and contact dealer.
- Using the Micromotor with light 'ON' for more than 3 minutes continuously, motor will become hot. (The maximum surface temperature might reach 45° C by the situation used) In such cases, stop using the Micromotor till the light part cools down, or use the Micromotor without turning on the light.
- Grounding reliability can only be achieved when the equipment is connected to an equipment receptacle marked "Hospital Only" or "Hospital Grade".
- For safety's sake, install the Control Unit in a place where the AC POWER Cord can be easily removed. (It is possible to disconnect the control unit from the power source by removing the AC POWER Cord.)

Operating Mode

| Intermittent Operation |         |
|------------------------|---------|
| ON                     | OFF     |
| 3 min.                 | 10 min. |

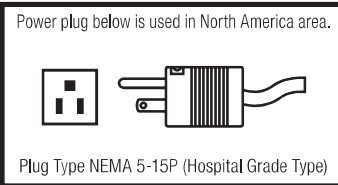

**⚠ NOTICE**

- Turn off the Main Power Switch after each use.
- For service requirements and spare parts contact dealer.
- Use pre-sterilized, disposable Irrigation Tube recommended by OSSTEM.

|                        | Temperature                 | Humidity          | Atmospheric pressure |
|------------------------|-----------------------------|-------------------|----------------------|
| Use                    | Between 0-40°C (32-104°F)   | Between 10-85% RH | -                    |
| Store (Transportation) | Between -10-50°C (14-122°F) | Between 10-85%RH  | Between 500-1060 hPa |

No moisture condensation in the Control Unit.  
Use at outside of these limits may cause malfunction.

## 2. Package Contents

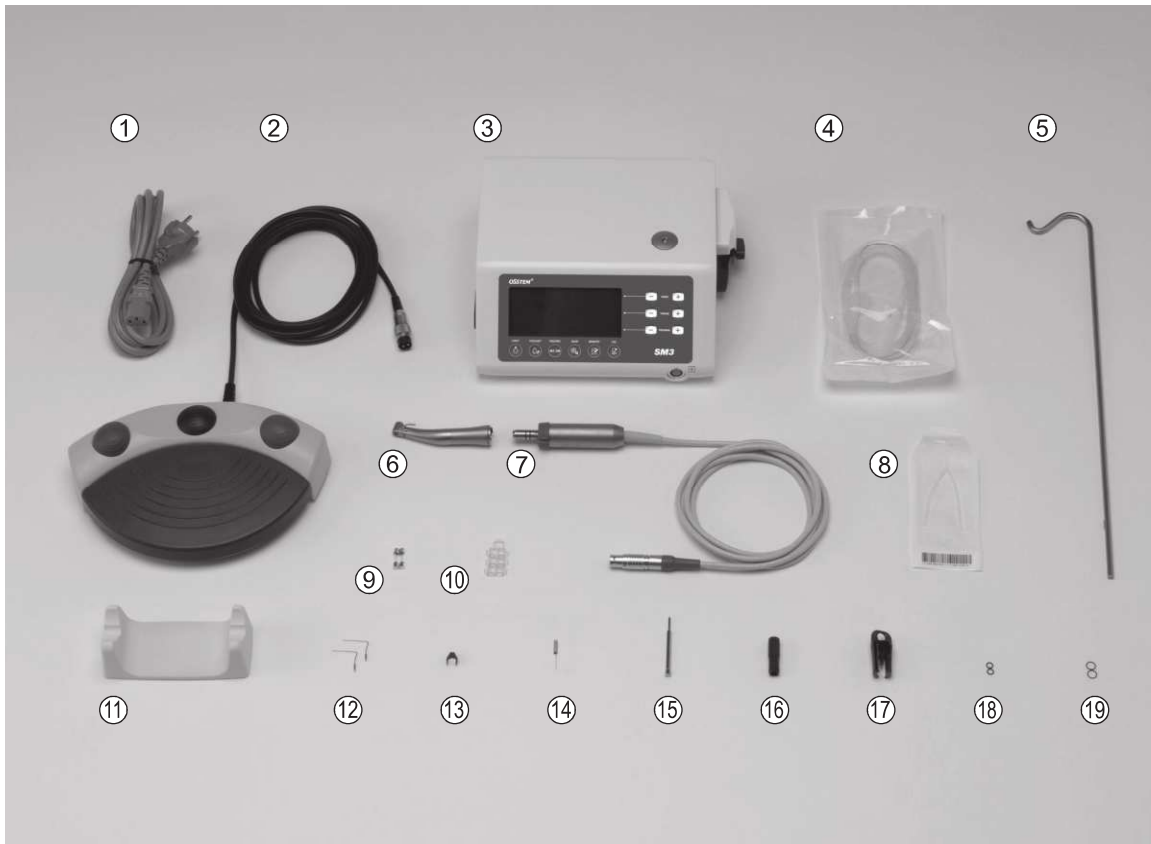

| Item No. | Description                    | Quantity |
|----------|--------------------------------|----------|
| ①        | AC Power Cord                  | 1        |
| ②        | Foot Controller with Cord (2m) | 1        |
| ③        | Control Unit                   | 1        |
| ④        | Irrigation Tube                | 3        |
| ⑤        | Coolant Solution Hanger Post   | 1        |
| ⑥        | Optic Handpiece                | 1        |
| ⑦        | Optic Motor (With Motor Cord)  | 1        |
| ⑧        | Y-Connector                    | 1        |
| ⑨        | Spare Fuse                     | 2        |
| ⑩        | Tube Holder                    | 7        |

| Item No. | Description                | Quantity |
|----------|----------------------------|----------|
| ⑪        | Handpiece Stand            | 1        |
| ⑫        | Internal Irrigation Nozzle | 1        |
| ⑬        | Nozzle Holder              | 1        |
| ⑭        | Cleaning Wire              | 1        |
| ⑮        | Calibration Bur            | 1        |
| ⑯        | E-type Spray Nozzle        | 1        |
| ⑰        | Protection Plug            | 1        |
| ⑱        | O-ring (Protection Plug)   | 2        |
| ⑲        | O-ring (Motor)             | 2        |

## 3. Control Unit and Foot Control

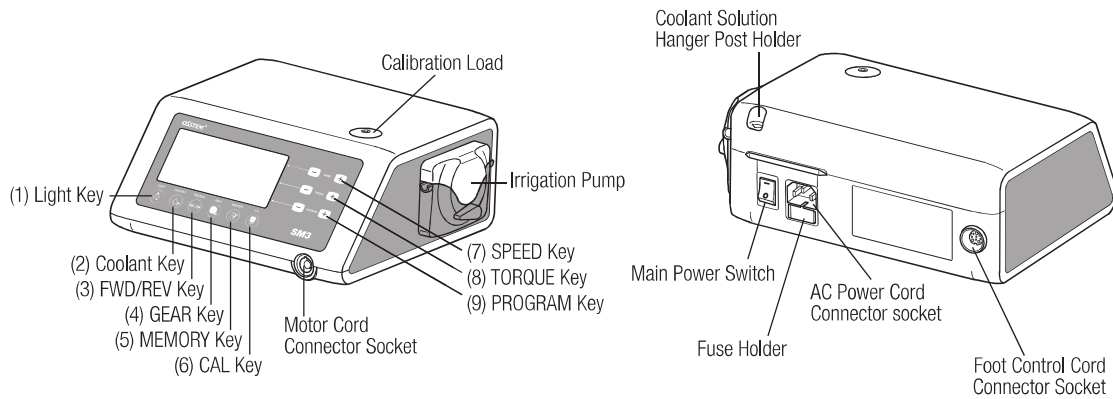

\*The item which does not have number is explained in context.

### 3-1 Keys on the Control Unit

- (1) Light Key  
Select the light level. (OFF -> LOW->HIGH) Repeat press Key to cycle through light levels. (Default:HIGH)
- (2) Coolant Key  
Use to select 6 levels of coolant solution flow from 0 to 5, repeat press Key to cycle through coolant flow levels.
- (3) FWD/REV Key  
Use to select the direction of rotation. Press this Key once to change the rotational direction. (Once in Reverse the Control Unit audibly warns with a 'beep')
- (4) GEAR Key  
Use to set gear ratio of the attached handpiece before use. Repeat press this Key until the LCD display indicates the correct gear ratio of the handpiece.
- (5) MEMORY Key  
Use to memorize the program parameters set by the operator. Press & hold this Key for approx. 1 second to memorize parameters. When beep sounds, the new program parameters have been memorized.
- (6) CAL Key  
Use to activate calibration cycle of the handpiece before use.
- (7) SPEED Key (- +)  
Use to set the Micromotor speed. Press [+] Key to increase, and [-] Key to decrease speed. When keep pushing the key to change the speed quickly. (When the upper and lower speed limits are reached an audible alarm 'beep' is sounded).
- (8) TORQUE Key (- +)  
Use to set the torque range. Press [+] Key to increase and [-] Key to decrease torque range. When keep pushing the key to change the torque range quickly. (When the upper and lower torque range limits are reached an audible alarm 'beep' is sounded). The torque range setting should be selected according to the attached handpiece gear ratio.
- (9) PROGRAM Key (- +)  
Select the available programs. (1 to 8) Press [+] Key to ascend and [-] Key to descend program number. You will find all program numbers sequentially by pressing Keys.

### 3-2 LCD display on the Control Unit Console

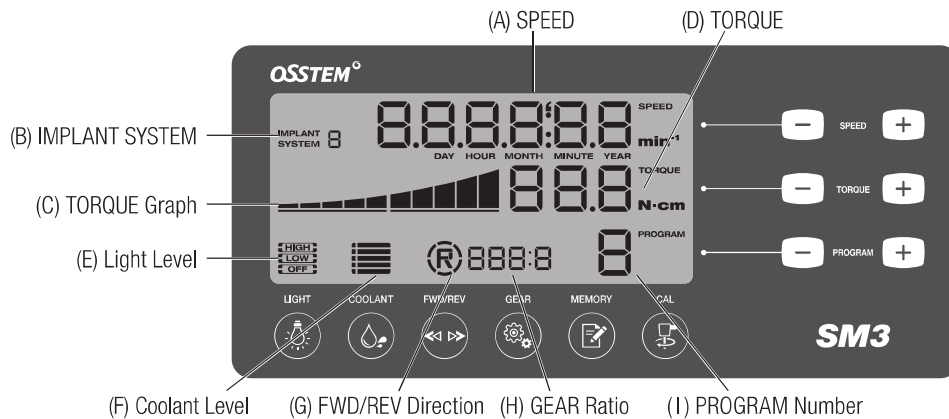

#### (A) SPEED

Selected speed indication. Rotation speed is displayed during rotation. When rotation stops, the maximum rotation speed set is displayed. Depressing Foot Control: Rotation speed of the motor displayed on the LCD (Assuming the correct gear ratio is selected) Foot Control speed varies depending on how far foot is depressed. Without pressing Foot Control: Max Rotation preset setting displayed on the LCD

#### (B) IMPLANT SYSTEM

The number of the implant system being used is displayed. (1 to 8)

#### (C) TORQUE Graph

Display the actual operating torque range. When all bars illuminate, the operating torque is at maximum. When bars are half illuminated then the operating torque is approximately 50% of the preset torque.

#### (D) TORQUE

Selected torque indication. When using the 1:1 direct drive or Speed increasing handpiece, the torque is not displayed. (This function is appropriate for 2:1 reduction speed handpiece or more)

#### (E) Light Level

Displays the selected light level; light levels are HIGH, LOW and OFF.

#### (F) Coolant Level

Displays the selected coolant solution flow level; the selected Flow level is indicated by 0 to 5 levels of illuminated indicators. No illumination indicates when the Coolant Solution Flow is off.

#### (G) FWD/REV Direction

Displays the selected direction of handpiece rotation. When rotating, the circumference display rotates.

#### (H) GEAR Ratio

Selected Gear Ratio of the handpiece.

#### (I) PROGRAM Number

Selected Program Number indication. (1 to 8)

### **NOTICE**

- When the power source is turned on, the device will return to its default settings. To save a setting, see 6-1 Programming the Micromotor Operation. (Default: Implant system 1, Light HIGH, Coolant Flow 3, Rotation F, Gear Ratio 20:1, Program Number 1, Torque 20N•cm, Speed 800 $\text{min}^{-1}$ )

### 3-3 Foot Control

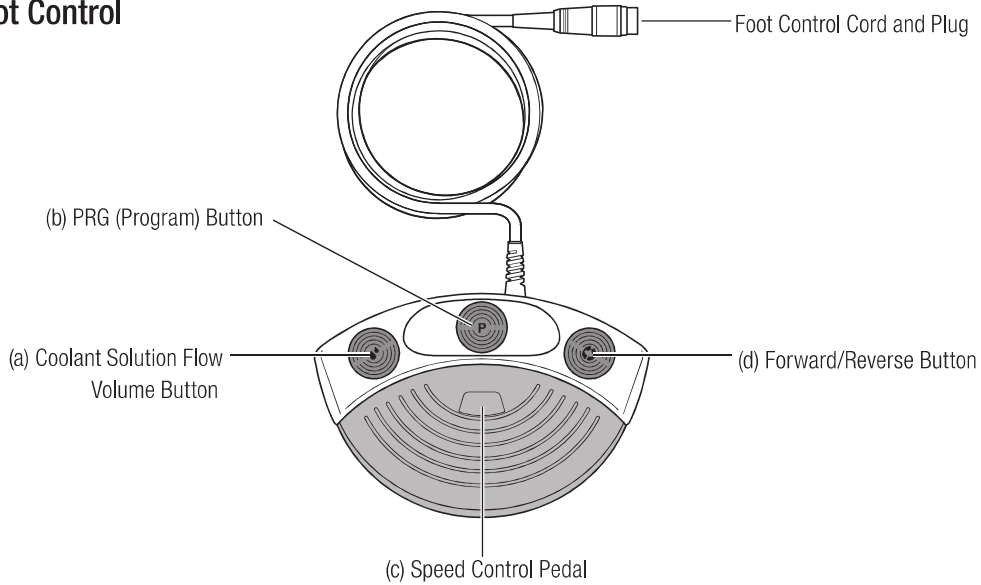

#### (a) Coolant Solution Flow Volume Button

Use to select 6 levels of coolant solution flow from 0 to 5; each level may be increased by one step pressing this button. If you press this button in level 5, it returns to level 0.

#### (b) PRG (Program) Button

Use to select the desired program number. Program numbers will always ascend each time this button is pressed and released. To descend, press and hold for 1 second then release.

#### (c) Speed Control Pedal

Use to start and stop the Micromotor and to control the speed during operation. The Micromotor operational speed is directly proportional to the position of the foot control, up to the preset maximum.

#### (d) Forward/Reverse Button

Use to change the rotational direction of the Micromotor. Push once to change the rotational direction.

## 4. Installation

### CAUTION

Install the cord/plug only power is OFF.

### 4-1 Connecting the Motor Cord

Align the [•] mark on the Motor Cord with [•] mark on the Control Unit.

Push the Base of Motor Cord Plug into the socket until the locking joint 'clicks' into place.

To disconnect the plug; pull back the Lock Joint, pull further to disconnect the cord.

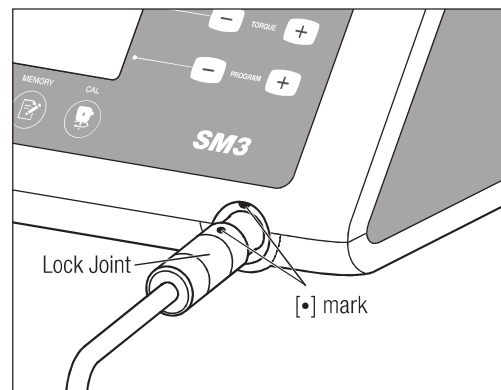

Fig.1

## 4-2 Connecting the Handpiece

### CAUTION

When using the SM3 micromotor (SL), USE ONLY Optic contra-angle handpieces. Non Optic handpieces may not precisely connect to the micromotor and it may malfunction when the micromotor is under load.

- 1) Push the handpiece on to the motor taking care to keep it in alignment.
- 2) Twist the handpiece until it locks into position with a clicking sound.

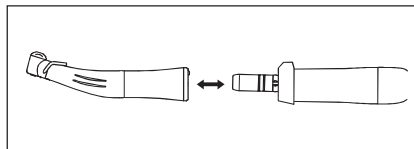

Fig.2

## 4-3 Connecting the Foot Control

Face the screw on the Foot Control Cord Plug downward then insert the plug into the Foot Control Cord connector socket on the Control Unit. Secure the plug by fastening the Lock Nut. (Fig. 3)

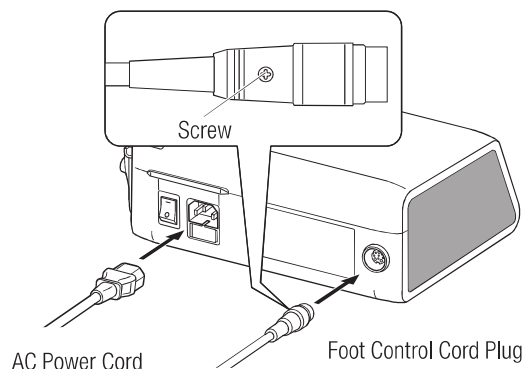

Fig.3

## 4-4 Connecting the AC Power Cord

Correctly align then insert the AC Power Cord into the AC Power Cord Connector Socket at the back of the Control Unit. (Fig.3)

## 4-5 Installing the Irrigation Tube

Ensure the Pump Cover Lever is in the 'OPEN' position, with the Irrigation tube 'Needle' towards the backside of the Control Unit. Position the stoppers of the tube assembly in to the Tube Guide securely. (Fig.4)

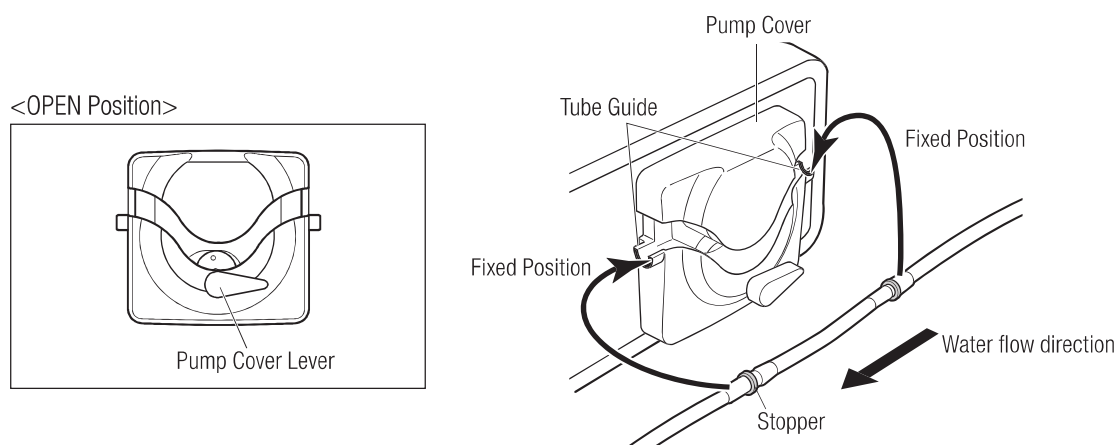

Fig.4

**CAUTION**

- Make sure that the tube is securely set on the rollers when closing the Pump Cover. If the tube is not correctly positioned on the Rollers and the cover is closed, the tube could be cut or sheared. (Fig.5)
- Do not mount the Irrigation Tube except the person who specially educated.
- Do not mount the Irrigation Tube during Power is ON.

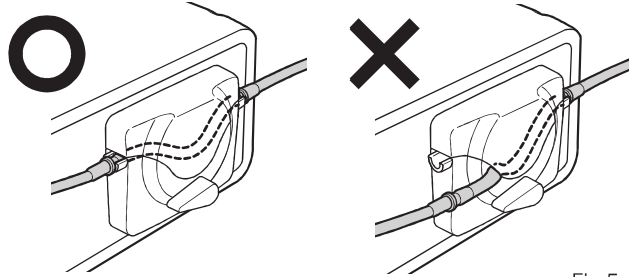

Fig.5

After the tubes are correctly positioned, close the Pump Cover by turning the Pump Cover Lever to the 'CLOSE' position. (180 degrees counterclockwise) (Fig.6)

To remove, 'OPEN' the Pump Cover Lever then remove the tube.

<CLOSE Position>

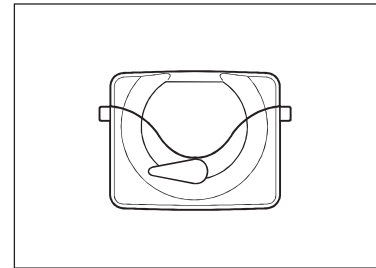

Fig.6

#### 4-6 Mounting the Coolant Solution Hanger Post

Mount the Coolant Solution Hanger Post onto the Holder on the Control Unit. (Fig.7)

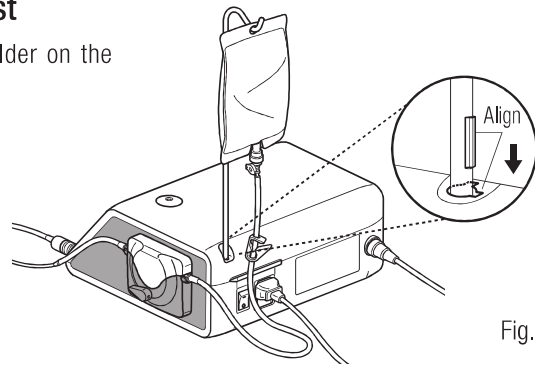

Fig.7

#### 4-7 Insertion of the Irrigation Tube

- 1) Close the Tube Clamp, between the Irrigation Tube Needle and the Irrigation Pump. (Fig.8)
- 2) Insert the Irrigation Tube Needle into the Bottle Cap. (Fig.9)
- 3) Open the Tube Cap to supply air into the bottle. (Fig.10)
- 4) Open the Tube Clamp.

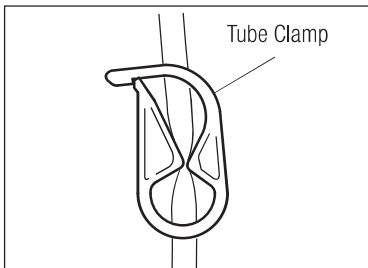

Fig.8

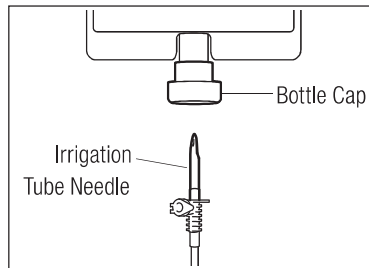

Fig.9

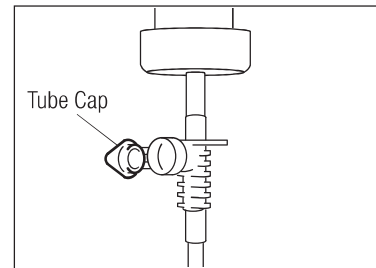

Fig.10

**CAUTION**

Do not operate the Irrigation Pump if the tube is bent or the Tube Clamp is in the closed position. This could cause the tube to burst or slip out of the bottle.

## 4-8 Compatibility check of Internal Irrigation Nozzle/Drill

Internal irrigation nozzles accompanied with this product; is not necessarily fitted into all the drills on the market. Follow the instructions given below for confirmation prior to use.

Failure to do so or to fit the Internal Irrigation Nozzle into drills may cause a leakage of saline solution, which will result in problems such as rust or sudden stop of equipment during use.

\* To mount the Drill, refer to attached Handpiece Operation Manual.

Instructions:

- 1) Attach a bottle of saline solution to the Control Unit.
- 2) Connect the Internal Irrigation Nozzle into the tip of the irrigation tube.
- 3) Insert the Internal Irrigation Nozzle into the drill from the back. (Fig.11)
- 4) Purge at "Maximum" for 5 seconds.

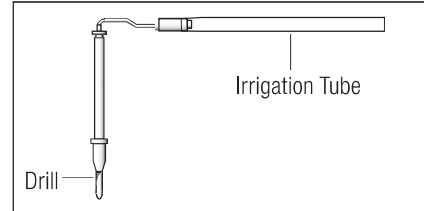

Fig.11

Points to be checked:

- Cleanliness of the saline solution coming out from the drill; if solution is colored there could be rust inside of the drill. If so renew the drill.
- Water Flow; if the flow is low and/or the flow from the drill is asymmetric, renew the drill.
- No water leakage between Internal Irrigation Nozzle and drill before use, ensure no water is leaking from the entry point of irrigation nozzle, a broken seal or no seal in the drill may be the cause. Replace the drill even if its new, saline solution ingress into handpiece will cause malfunction.

### **CAUTION**

If malfunction such as a leakage of saline solution from the back of Contra Head is detected during use, stop using and perform some troubleshooting.

## 4-9 Irrigation Nozzle Attachment

S200EL has 3 irrigation methods available depending on tool and application; External, Internal or both, for installation detail, refer to the attached handpiece Operation Manual.

## 4-10 Attaching the Tube Holder

Use the Motor Cord as a strain relief for the 'Irrigation Tube'. It is easier to insert Motor Cord first, then the Irrigation Tube. (Fig.12)

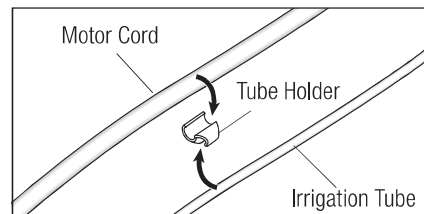

Fig.12

## 5. Setting

### 5-1 Illumination Adjustment

Repeat press LIGHT key to cycle through light levels. Pressing LIGHT key to change illumination volume. (OFF → LOW → HIGH) (Default is HIGH)

To save the changes, press the MEMORY key for at least 2 seconds.

#### NOTICE

- Repeat the above procedures when restoring operation.
- The lamp status will remain set even if the power is switched “OFF” and “ON”.
- This function is only applicable for an optic motor and handpiece.

### 5-2 Sound Volume

It is possible to change the volume for operation and warning sounds for keys.

1) Turn on the power while pressing the [CAL] key.

2) When turning ON, the volume will alternate between “Large” and “Low.” (The default is “Low”)

\* Sound Volume is not displayed on LCD. The actual sound changes.

#### NOTICE

Settings will be saved even if the power is turned off.

### 5-3 Factory Settings

When initialized, the device will revert to factory settings. Preferred settings and programs, etc. will be erased, so be sure to make memos of them.

1) Turn power on while pressing the PROGRAM (+ -) Key.

2) “Set” will come up on the LCD Display. (there will also be a short beep) By pressing [CAL] key, the device will revert to factory settings.

3) “Fin” will come up on the LCD Display. (there will also be a long beep) Initializing is complete when the screen goes back to its usual display.

## 6. Operation

### 6-1 Programming the Micromotor Operation

The Control Unit can memorize 8 programs. Each program includes the following functions which will be automatically performed when the appropriate program number is selected.

Gear ratio of contra angle handpieces  
Speed  
Direction of rotation  
Torque upper limit  
Coolant Solution Flow  
Light Level

|                             |     |    |
|-----------------------------|-----|----|
| Power Switch<br>Symbol Mark | ○   | -  |
| Function                    | OFF | ON |

- 1) Turn on the power by pushing the Main Power Switch toward [-]; on power up IMPLANT SYSTEM Number 1 program number 1 is displayed by default.
- 2) Select a program number by using either step (a) or step (b):
  - (a) Press the PROGRAM (+ -) Key on the Control Panel until the desired program number is displayed.
  - (b) Press the PRG(Program) Button on the Foot Control until the desired program number is displayed.
- 3) Selecting the Rotate direction of the handpiece. Select it by using either step (a) or (b):
  - (a) Press FWD/REV Key on the Control Panel until the desired direction is displayed.
  - (b) Press the Forward/Reverse Button on the Foot Control until the desired direction is displayed.

#### NOTICE

- There will be a beeping sound while “R” is pressed.
- Beeping sounds heard during rotations and when the device is stopped are not the same. Different sounds do not indicate a malfunction.

- 4) Selecting the Gear ratio of contra angle handpieces relevant to the program; Press the GEAR Key to select the gear ratio of the handpiece (Gear Ratio will display on the LCD).
- 5) Set the required max operating speed by pressing the SPEED (+ -) Key. Each time this Key is pressed display changes to the next speed level. By pressing this Key for more than 1 second brings the speed quickly to the next level until the speed display reaches its upper or lower limit.
  - When the speed setting reaches the upper or the lower limit, an audible beep is heard and the speed setting cannot be changed any further.
- 6) Set the torque upper limit by pressing the TORQUE Key on the Control Panel. Each time this Key is pressed display changes to the next torque level. By pressing this Key for more than 1 second brings the torque quickly to the next level until the torque display reaches its upper or lower limit.
  - When the torque setting reaches the upper or the lower limit, an audible beep is heard and the torque setting cannot be changed any further.
- 7) The level of Coolant Solution Flow volume has 6 Flow level (0-5) (0 = no coolant Flow). Select a Coolant Solution Flow Volume using either step (a) or step (b):
  - (a) Press the COOLANT Key on the Control Panel until the desired flow level is displayed.
  - (b) Press the Coolant Solution Flow Volume Button on the Foot Control until the desired flow level is displayed.
- 8) After completing steps 2) - 7). press and hold MEMORY Key until beep is heard. The beep confirms that the programming is completed. If you hear a short beep when the MEMORY Key is first pressed ignore this sound and keep the MEMORY Key depressed until a long beep is heard.

\* Repeat the above steps 2) - 8) to program any one of the 8 available programs.

#### 6-1-1 Program Skip Function

When switching programs using the Foot Control, Program Numbers that are not chosen can be chosen ahead of time.

- 1) Choose Program Numbers that you want the Control Unit to skip.
- 2) Use the SPEED (-) Key to display the Minimum Rotation Speed.
- 3) Release the SPEED (-) Key, and then push it again. Display “---” on the LCD.
- 4) Push the MEMORY Key until it beeps (about 2 seconds) to memorize.

## ⚠ NOTICE

It is possible to choose programs that have been skipped using the Control Unit.

## 6-2 IMPLANT SYSTEM

SM3 Series can memorize 8 different IMPLANT SYSTEMs. Also, you can program 8 steps in one SYSTEM number which you use. When you set the program, refer to values which Implant manufacture recommends.

When programming each IMPLANT SYSTEM, the SYSTEM number may be changed by pressing the PROGRAM (+) and (-) Key simultaneously.

## 6-3 Calibration Function

The rotation resistance of a handpiece depends on the handpiece model, condition, and internal wear of the handpiece gears. This Control Unit incorporates an automatic function to recognize the level of the resistance of the attached handpiece and motor.

### ⚠ NOTICE

- This equipment is optimized to obtain the highest calibration accuracy at a gear ratio of 20:1. For calibration USE ONLY the 20:1 reduction handpiece listed on "12. Contra Angle Handpieces and Accessories".
- Micro saw handpiece should not be calibrated.
- Calibration should be performed only on OSSTEM handpiece.

### 6-3-1 Calibration preparation

- 1) Attach Gear Ratio (Reduction Ratio) 20:1 handpiece to the motor.
- 2) Attach the Calibration Bur to the handpiece.
- 3) Press the [CAL] key for about 2 seconds. There will be a beep and the display will switch to Calibration Mode.

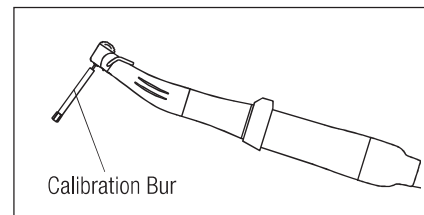

Fig.14

### 6-3-2 Conducting Calibration

#### ⚠ CAUTION

Do not apply load during no-load calibration. If load is applied, "FAIL" will appear on the LCD, and calibration will stop.

- 1) No-load calibration ... torque display "L"

Hold the motor in your hand and make sure that "L" is displayed on the torque display. Push [CAL] key without applying load. The calibration bur will begin to rotate. Calibration is complete when there is a beep and "donE" appears on the display.



- 2) Load calibration... torque display "H"

Make sure "H" is displayed on the torque display, plug the calibration bur into the Torque Lord Push [CAL] key (The calibration is done while applying torque load, so securely grasp the handpiece. The calibration bur will begin to rotate. Calibration is complete when there is a beep and "donE" appears on the display).

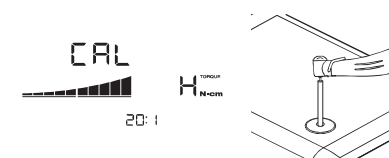

- 3) Speed calibration

Remove the bur from the Torque Lord then press the [CAL] key (Calibration bur should not touch anywhere). The bur will begin to rotate at a slow speed. After rotating slowly for 8 seconds, the bur will rotate at high speed for 8 seconds. There will a beep when calibration is complete. Calibration mode will finish automatically.



**⚠ CAUTION**

During a process, it is important to hold the Calibration Bur vertically without applying any forcible power. Making the Calibration Bur tilt or pressing it may cause a loss in accuracy.

**Calibration fail example**

- Extreme gear abrasion and mechanical loss can exceed the control limits. Correct data cannot be obtained during calibration cycle and the calibration will fail. In this case, request repair.
- If nonconformities such as extreme abrasion of the gear and mechanical loss exceed the control limit, correct data cannot be obtained during calibration will fail. In this case, request repair.
- Calibration fail; if the calibration bur makes contact with something during no load calibration or no load is erroneously applied during load calibration.

## 6-4 Standard Operation

- 1) Select the desired program number.  
Control Unit: Press PROGRAM (+ -) Key.  
Foot Control: Step on the Foot Control PRG (Program) Pressing the PRG (Program) Button for 1 second more will descend the to the next program number.
- 2) Step on the Speed Control Pedal in the middle of the Foot Control the motor will start to run. The Coolant Pump will also run (if programmed). Speed increases as the pedal is depressed. When the Speed Control Pedal is fully depressed the speed reaches the maximum preset value.
- 3) Reversing the motor rotational direction: To reverse direction of the motor (and bur) simply step on the Foot Control Forward/Reverse Button. A warning beep can be heard when the rotational direction is in reverse mode.



**⚠ CAUTION**

- Using the Micromotor with light 'ON' for more than 3 minutes continuously, motor will become hot (The maximum surface temperature might reach 45°C by the situation used). In such cases, stop using the Micromotor till the light part cools down, or use the Micromotor without turning on the light.
- Activation of the torque limiter: During use, when the drilling load reaches the preset torque upper limit, the integrated torque limiter automatically activates to prevent over torque. When the torque limiter activates, the motor stops after beeping for 1 second. To reactivate the Micromotor, release the speed control pedal and depress it again.

- 4) Release the Foot Control Pedal, and the Micromotor will automatically stop.

## 7. Protection Circuit

An electronic circuit breaker automatically functions to protect the motor and the Control Unit if the motor is ever overloaded. Power supply to the motor will automatically be terminated and an Error code will be displayed on the Control Unit.

When torque exceeds the set figures, "SAFE" will appear on the LCD, and the device will stop.

\*Resetting the Protection Circuit

To reset the Protection Circuit, release and then depress the Speed Control Pedal.

## 8. Error Code & Troubleshooting

If an operational problem occurs the display will show an Error Code allowing immediate problem diagnosis.

When an error occurs, there will be a beep and an Error Code will appear on the LCD. The Error Code will blink until the error is alleviated.

| Error code | Error Mode                                | Cause of Error  | Remedy   |
|------------|---|---|--|
| E1         | Excessive Current Detected.               | Extended use under heavy load.<br>Short circuit in the motor.   | Electrical contact may be insufficient.<br>Securely re-connect the Motor Cord.<br>When an error cannot be eliminated, request repair.  |
| E2         | Excessive Voltage Detected.               | Motor cord failure.   |  |
| E3         | Motor Sensor Error.                       | Motor sensor failure (Hall IC).<br>Motor Cord failure.  |  |
|            |   | Ingress of water into a Motor.  | Request repair.<br>Make sure to put a Protection Plug when Thermo-disinfecting it.   |
| E4         | Control Unit Interior Over-heating Error. | Overheating by extended use under heavy load.<br>Operation of the Control Unit under an extremely high temperature. | Allow it to cool down before use.<br>Since heat is sufficiently radiated, periphery of the main Control Unit should be well-ventilated wherever possible. When an error cannot be eliminated, request repair.    |
| E5         | Breaking Error.                           | Abnormal voltage generated in the start / stop switch circuit.<br>Failure in the start / stop switches circuit.     | When rotation and stop are repeated in short frequencies, a circuit may be activated which limits acceleration at start. Wait a few seconds and then use.<br>When an error cannot be eliminated, request repair. |
| E6         | Motor Rotation Failure Error.             | Handpiece attachment failure.<br>Motor failure.   | The chuck may be opened, or may not be sufficiently closed. Securely close the chuck.<br>When an error cannot be eliminated, request repair.   |

|     |                           |   |  |
|-----|---------------------------|---|--|
| E7  | Pump excess voltage.      | The Irrigation tube is incorrectly fitted and loading the pump roller.<br>The pump fails. | Check the Irrigation tube.<br>If an Error Code is displayed even when the Irrigation tube is normal, request repair.                       |
| E8  | Pump excess current.      |   |  |
| E9  | Foot Control abnormality. | Connection failure of the connector.<br>Failure of the inside of the Foot Control.        | Check the connection state of the connector.<br>The Error Code is displayed even when the connector is normally connected, request repair. |
| E10 | LED excess voltage        | Failure of LED circuit.   | Request repair.  |
| E11 | LED excess current        | Check if the saline solution hasn't penetrated the motor lamp.                            | Remove the saline solution completely.   |
|     |                           | Failure of LED circuit.   | Request repair.  |

| Error  | Cause of Error                                   | Remedy   |
|--|--|--|
| Screen is blank.   | Plug to power source is not properly inserted.   | Check to make plug is in.  |
|  | Blown fuse.                                      | Replace fuse.  |
|  | Malfunction of power switch.                     | Request repair.  |
| Rotation number display is "--" and numbers are displayed and numbers alternate. | Power is on while Foot Control is being pressed. | Remove foot from Foot Control.   |
|  | Foot Control malfunction.                        | If the problem is solved by removing the Foot Control, the Foot Control has malfunctioned. Repair is required. |
|  | Control Unit malfunction.                        | If the problem is not solved by removing the Foot Control, the unit has malfunctioned. Repair is required.     |
| Will not rotate even if the Foot Control is pressed.                             | Cord connection is loose.                        | Check connection.  |
|  | Malfunction of Control Unit or Foot Control.     | If the problem is not solved by checking the connection, system repair is required.                            |

## 9. Fuse Replacement

If the Control Unit does not function, check the fuses (Fuse Box lock located on the rear of the Control Unit). To access the Fuse, use a pointed tool push on the fuse locking latch and the drawer will spring open. (Fig.16)

| Fuse Ratings |         |      |
|--------------|---------|------|
| 120V         | T3.15AL | 250V |
| 230V         | T1.6AL  | 250V |

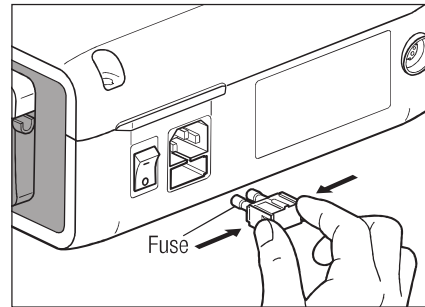



Fig.16

## 10. Maintenance

### 10-1 Maintenance of the Control Unit and Foot Control

If blood or saline solution has stained the Control Unit or Foot Control, remove the AC Electrical Cord; wipe Control Unit or Foot Control with a damp cloth, then with an alcohol-absorbed cloth.

### 10-2 Maintenance of the Handpiece and Motor

 This handpiece and motor can be cleaned and disinfected with a Thermo-Disinfector.

Attach the Protection Plug to the motor.

For detail, refer to the Thermo-Disinfector's Operation Manual.

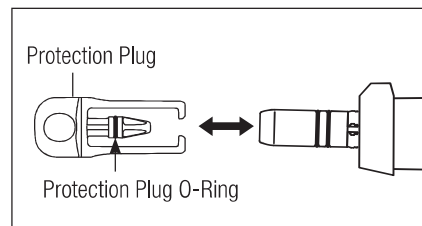

Fig.17

### CAUTION

- Always use the Protection Plug during Thermo-Disinfector.
- Do not use Protection Plug without the mounting O-Ring. It may cause a malfunction. If O-Ring had damaged, replace it immediately.

### NOTICE

Protection Plug O-ring is consumable supply. If it damaged, replace it new one.  
Optional Protection Plug: Order Code 10001595  
Protection Plug O-Ring: Order Code D0312457102

## 11. Sterilization

 This handpiece and motor can be autoclavable up to Max.135°C.

- Autoclave sterilization is recommended.
- Autoclave sterilization is required for the first time use and after each patient as noted below.

### CAUTION

Only Items Specified below can be autoclaved.

The following items can be autoclaved.

- Handpiece
- Internal Irrigation Nozzle
- Protection Plug
- Micromotor with Motor Cord
- Tube Holder
- Calibration Bur
- Handpiece Stand
- Nozzle Holder

### \*Autoclaving

- 1) Remove blood and debris from the handpiece and motor.
- 2) Clean inside the handpiece; by using the spray lubricant
- 3) Place those in autoclave pouch (not included in the package) and seal it.
- 4) Autoclavable up to max. 135°C.  
ex.) Autoclave for 20 min. at 121°C, or 3 min. at 134°C.
- 5) Keep the handpiece in the autoclave pouch to keep it clean until you use it.  
\* EN13060/EN ISO17665-1 recommends autoclaving for 3 minutes (minimum holding time) at 134°C or 15 minutes (minimum holding time) at 121°C.  
OSSTEM recommends Class B sterilization.

### CAUTION

- Clean and lubricate the handpiece before autoclaving. Autoclaving a handpiece stained with blood or debris could cause damage to the handpiece.
- Do not lubricate the micromotor.
- Do not disconnect the motor cord from the micromotor.
- The Irrigation tube is a single use and cannot be autoclaved.
- We do not recommend you to sterilize on plasma sterilization or EOG sterilization.

## 12. Contra Angle Handpieces and Accessories

Listed below are the contra angle handpieces which should be used with the SM3 micromotor to guarantee torque accuracy.

| Order Code | Description | Remarks                   |
|------------|-------------|---------------------------|
| C1003      | S200EL      | Optic surgical handpiece. |

| Order Code | Description                | Remarks  |
|------------|----------------------------|--|
| C823752    | Y-Connector                | Used for branching the internal and external coolant irrigation. |
| Z0263001   | Irrigation tube            | For replacement tube use.  |
| 20000396   | Nozzle Holder              | Supplied as standard accessory items.                            |
| 10000324   | Internal Irrigation Nozzle | Supplied as standard accessory.                                  |
| Y900083    | Tube Holder                | Supplied as standard accessory for Irrigation Nozzle.            |
| Z182100    | PANA SPRAY Plus            | For High & Low speed handpieces.                                 |

## 13. Specification

(Control Unit)

|                      |                  |
|----------------------|------------------|
| Model                | SM3              |
| Type                 | NE294            |
| Power Supply Voltage | AC120/230V       |
| Frequency            | 50/60Hz          |
| Power Consumption    | 40VA             |
| Max. Pump Output     | 75ml/min         |
| Dimensions           | W265xD220xH100mm |

(Micromotor)

|                      |                                |
|----------------------|--------------------------------|
| Model                | SL                             |
| Type                 | E1023                          |
| Rotation Speed Range | 200 – 40,000 min <sup>-1</sup> |
| Input Voltage        | DC24V                          |
| Dimensions           | Ø23.5xL103.3mm (without cord)  |
| Cord Length          | 2m                             |
| OPTIC                | White LED                      |

(Foot Control)

|             |       |
|-------------|-------|
| Model       | FC-78 |
| Cord Length | 2m    |

## 14. Disposing Product

Consult with dealer from whom you purchased it about waste disposal.

## 15. Symbols



TUV Rhineland of North America is a Nationally Recognized Testing Laboratory (NRTL) in the United States and is accredited by the Standards Council of Canada to certify electro-medical products with Canadian National Standards.



This product is designed not to become the ignition source in air and flammable anesthetic gas.



The EU directive 93/42/EEC was applied in the design and production of this medical device.



Protected against the effects of continuous immersion in dust and water.



Dispose of this device and its accessories via methods approved for electronic device and in compliance with the Directive 2012/19/EU.



Type BF applied part



See Operation Manual



Marking on the outside of Equipment or Equipment parts that include RF transmitters or that apply RF electromagnetic energy for diagnosis or treatment.

## 16. EMC Information (Electromagnetic Compatibility Information)

| Guidance and manufacturer's declaration - Electromagnetic Emissions.   |            |  |
|--|------------|--|
| SM3 is intended for use in the electromagnetic environment specified below. The customer or the user of the SM3 should assure that is used in such an environment. |            |  |
| Emissions test   | Compliance | Electromagnetic environment - guidance   |
| RF emissions<br>CISPR11/EN55011  | Group 1    | SM3 uses RF energy only for its internal function. Therefore, its RF emissions are very low and are not likely to cause any interference in nearby electronic equipment.   |
| RF emissions<br>CISPR11/EN55011  | Class B    | SM3 is suitable for use in all establishments, including domestic establishments and those directly connected to the public low-voltage power supply network that supplies buildings used for domestic purposes. |
| Harmonic emissions<br>IEC61000-3-2/EN61000-3-2   | Class A    |  |
| Voltage fluctuations/flicker emissions<br>IEC61000-3-3/EN61000-3-3   | Complies   |  |

| Guidance and manufacturer's declaration - Electromagnetic Immunity  |   |   |  |
|---|---|---|--|
| SM3 is intended for use in the electromagnetic environment specified below. The customer or the user of the SM3 should assure that it is used in such an environment. |   |   |  |
| Immunity test   | IEC/EN60601 test level  | Compliance level  | Electromagnetic environment - guidance   |
| Electrostatic discharge (ESD)<br>IEC61000-4-2/EN61000-4-2   | ± (2, 4) 6 kV contact<br>± (2, 4) 8 kV air  | ± (2, 4) 6 kV contact<br>± (2, 4) 8 kV air  | Floors should be wood, concrete or ceramic tile. If floors are covered with synthetic material, the relative humidity should be at least 30%.  |
| Electrical fast transient/burst<br>IEC61000-4-4/EN61000-4-4   | ± 2kV for power supply lines<br>± 1kV for input/output lines  | ± 2kV for power supply lines<br>± 1kV for input/output lines  | Mains power quality should be that of a typical commercial or hospital environment.  |
| Surge<br>IEC61000-4-5/EN61000-4-5   | ± 1kV differential mode<br>± 2kV common mode  | ± 1kV differential mode<br>± 2kV common mode  | Mains power quality should be that of a typical commercial or hospital environment.  |
| Voltage dips, short interruptions and voltage variations on power supply input lines<br>IEC61000-4-11/EN61000-4-11  | <5% Ut (>95% dip in Ut) for 0.5 cycle<br><br>40% Ut (60% dip in Ut) for 5 cycles<br><br>70% Ut (30% dip in Ut) for 25 cycles<br><br><5% Ut (>95% dip in Ut) for 5 sec | <5% Ut (>95% dip in Ut) for 0.5 cycle<br><br>40% Ut (60% dip in Ut) for 5 cycles<br><br>70% Ut (30% dip in Ut) for 25 cycles<br><br><5% Ut (>95% dip in Ut) for 5 sec | Mains power quality should be that of a typical commercial or hospital environment. If the user of the SM3 requires continued operation during power mains interruptions, it is recommended that the SM3 be powered from an uninterruptible power supply or a battery. |
| Power frequency (50/60Hz) magnetic Field<br>IEC61000-4-8/EN61000-4-8  | 3A/m  | 3A/m  | Power frequency magnetic fields should be at levels characteristic of a typical location in a typical commercial or hospital environment.  |
| NOTE 'Ut' is the AC mains voltage prior to application of the test level.   |   |   |  |

| Guidance and manufacturer's declaration - electromagnetic immunity   |                            |                  |  |
|--|----------------------------|------------------|--|
| SM3 is intended for use in the electromagnetic environment specified below.<br>The customer or the user of the SM3 should assure that it is used in such an environment.   |                            |                  |  |
| Immunity test  | IEC/EN60601 test level     | Compliance level | Electromagnetic environment - guidance   |
| Conducted<br>RF IEC61000-4-6/EN61000-4-6   | 3V rms<br>150 kHz to 80MHz | 3V rms           | Portable and mobile RF communications equipment should be used no closer to any part of the SM3, including cables, than the recommended separation distance calculated from the equation applicable to the frequency of the transmitter.   |
| Radiated RF<br>IEC61000-4-3/EN61000-4-3  | 3V/m<br>80MHz to 2.5 GHz   | 3V rms           | Recommended separation distance<br>$d = 1.2\sqrt{P}$<br>$d = 1.2\sqrt{P}$ 80MHz to 800MHz<br>$d = 2.3\sqrt{P}$ 800MHz to 2.5GHz<br><br>Where $P$ is the maximum output power rating of the transmitter in watts (W) according to the transmitter manufacturer, and ( $d$ ) is the recommended separation distance in meters (m).<br><br>Field strengths from fixed RF transmitters as determined by an electromagnetic site survey(a) should be less than the compliance level in each frequency range(b).<br><br>Interference may occur in the vicinity of equipment marked with the following symbol:<br> |
| <b>NOTE1</b> At 80MHz and 800MHz, the higher frequency range applies.  |                            |                  |  |
| <b>NOTE2</b> These guidelines may not apply in all situations. Electromagnetic propagation is affected by absorption and reflection from structures, objects and people.   |                            |                  |  |
| <p><b>a</b> Field strengths from fixed transmitters, such as base stations for radio (cellular/cordless) telephones and land mobile radios, amateur radio, AM and FM radio broadcast and TV broadcast cannot be predicted theoretically with accuracy. To assess the electromagnetic environment due to fixed RF transmitters, an electromagnetic site survey should be considered. If the measured field strength in the location in which the SM3 is used exceeds the applicable RF compliance level stated above, the SM3 should be observed to verify normal operation. If abnormal performance is observed, additional measures may be necessary, such as reorienting or relocating the SM3.</p> <p><b>b</b> Over the 150kHz to 80MHz frequency range, the field strength should be less than 3V/m.</p> |                            |                  |  |

| Cables and accessories     | Maximum length | Shield     | Complies with  |
|----------------------------|----------------|------------|--|
| Micromotor with Motor Cord | 2.0M           | Unshielded | RF emissions, CISPR11: Class B/ Group 1  |
| Foot Controller with Cord  | 2.0M           | Unshielded | Harmonic emissions: IEC61000-3-2/EN61000-3-2   |
| AC Power Cord              | 2.0M           | Unshielded | Voltage fluctuations/ flicker emission: IEC61000-3-3/EN61000-3-3   |
|                            |                |            | Electrostatic discharge (ESD): IEC61000-4-2/EN61000-4-2  |
|                            |                |            | Electrical fast transient/burst IEC61000-4-4/EN61000-4-4   |
|                            |                |            | Surge: IEC61000-4-5/EN61000-4-5  |
|                            |                |            | Voltage dips, short interruptions and voltage variations on power supply input lines: IEC61000-4-11/EN61000-4-11 |
|                            |                |            | Power frequency(50/60Hz) magnetic field: IEC61000-4-8/EN61000-4-8  |
|                            |                |            | Conducted RF: IEC61000-4-6/EN61000-4-6   |
|                            |                |            | Radiated RF: IEC61000-4-3/EN61000-4-3  |

| Recommended separation distances between portable and mobile RF communications equipment and the SM3.   |  |                                    |                                     |
|---|--|------------------------------------|-------------------------------------|
| The SM3 is intended for use in an electromagnetic environment in which radiated RF disturbances are controlled. The customer or the user of the SM3 can help prevent electromagnetic interference by maintaining a minimum distance between portable and mobile RF communications equipment (transmitters) and the SM3 as recommended below, according to the maximum output power of the communications equipment. |  |                                    |                                     |
| Rated maximum output power of transmitter<br>W  | Separation distance according to frequency of transmitter<br>m |                                    |                                     |
|   | 150kHz to 80MHz<br>$d=1.2\sqrt{P}$                             | 80MHz to 800MHz<br>$d=1.2\sqrt{P}$ | 800MHz to 2.5GHz<br>$d=2.3\sqrt{P}$ |
| 0.01  | 0.12   | 0.12                               | 0.23                                |
| 0.1   | 0.38   | 0.38                               | 0.73                                |
| 1   | 1.2  | 1.2                                | 2.3                                 |
| 10  | 3.8  | 3.8                                | 7.3                                 |
| 100   | 12   | 12                                 | 23                                  |
| For transmitters rated at a maximum output power not listed above, the recommended separation distance 'd' in meters (m) can be estimated using the equation applicable to the frequency of the transmitter, where 'P' is the maximum output power rating of the transmitter in watts (W) according to the transmitter manufacturer.  |  |                                    |                                     |
| <b>NOTE1</b> At 80 MHz and 800 MHz, the separation distance for the higher frequency range applies.   |  |                                    |                                     |
| <b>NOTE2</b> These guidelines may not apply in all situations. Electromagnetic propagation is affected by absorption and reflection from structures, objects and people.  |  |                                    |                                     |

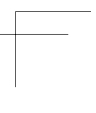
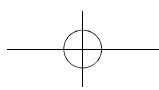
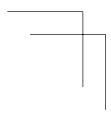
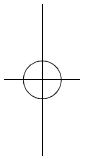
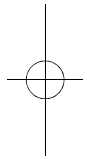
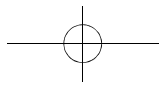
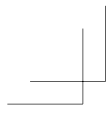

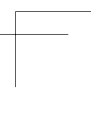
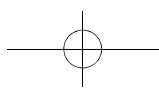
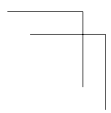
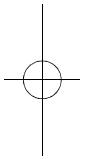
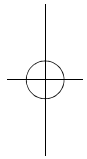
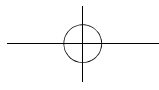
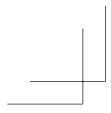

Distributor

**OSSTEM IMPLANT Co., Ltd.**

8th FL. WorldMeridian Center II, Gasan Digital 2-ro 123,  
Geumcheon-gu, Seoul 153-759

Manufacturer

**NAKANISHI INC.** 

700 Shimohinata, Kanuma, Tochigi 322-8666, Japan

EC Rep.

**NSK Europe GmbH** 

Elly-Beinhorn-Strasse 8, 65760 Eschborn, Germany

Specifications are subject to change without notice.

2015.07.20 005 